

APPIA 2-3GR SPARE PARTS

PRODOTTI / RICAMBI
PRODUCTS / SPARE PARTS
PRODUITS / PIÈCES DÉTACHÉES
PRODUKTE / ERSATZTEILE
PRODUCTOS / REPUESTOS

APPIA 2/3 GRUPPI

08-02-2006



PLATON SERVICE
8 (800) 500-34-41
www.platonservice.com



nuova simonelli

COMPONENTI GRUPPO CARENA

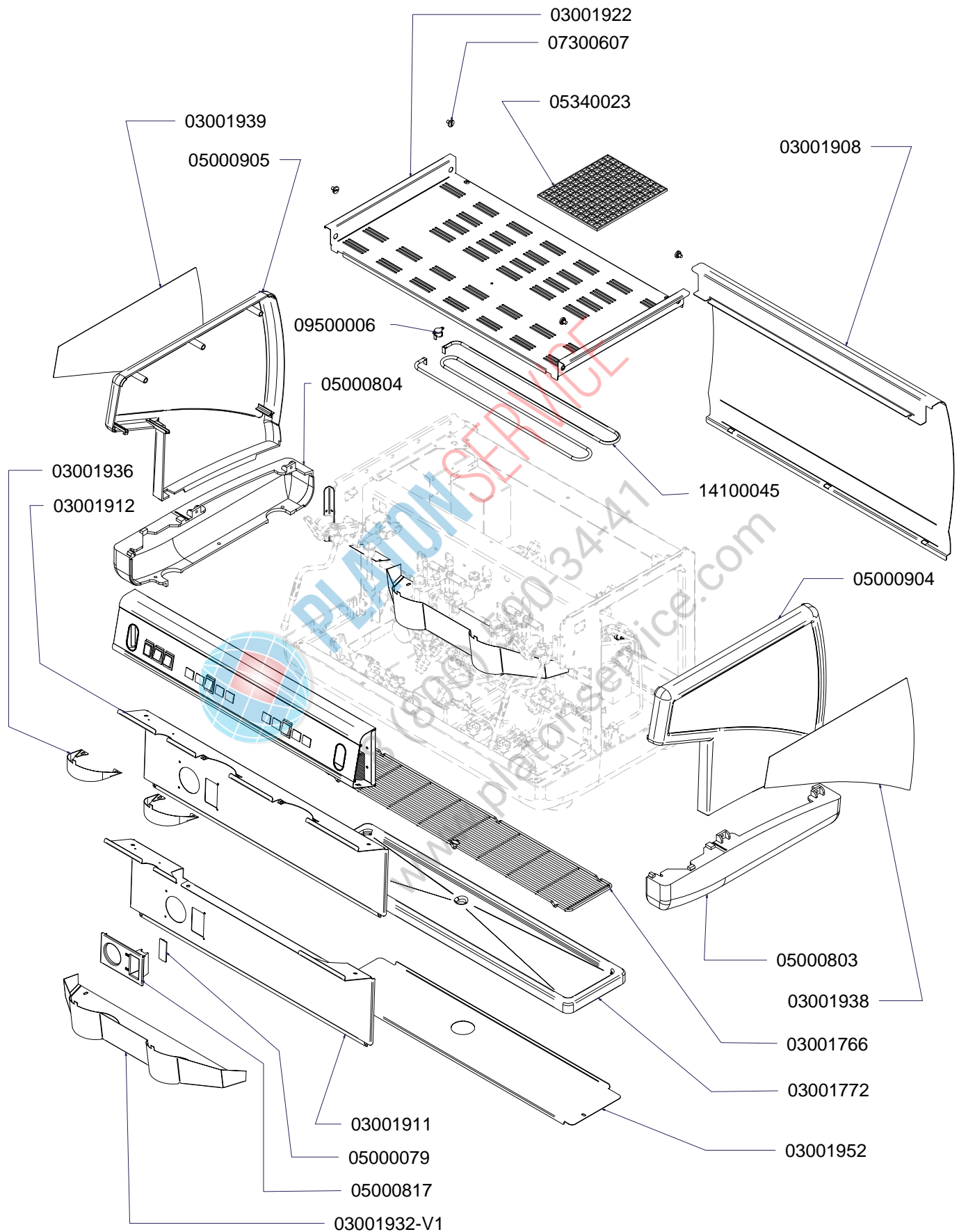

COMPONENTI GRUPPO INVOLUCRO COMANDI

APPIA 2-3GR SPARE PARTS

A
P
P
I
A

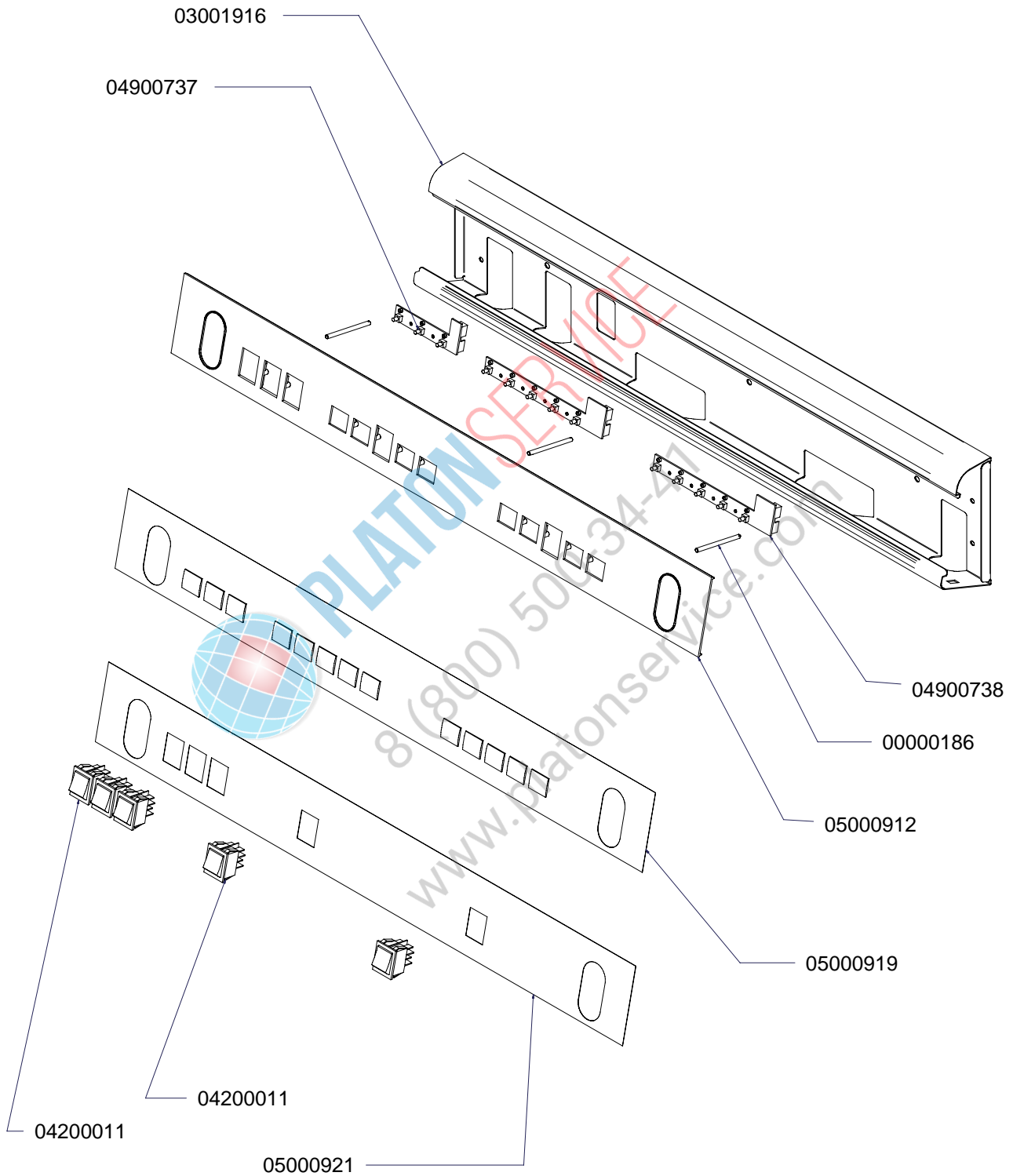

COMPONENTI GRUPPO EROGAZIONE

A
P
P
I
A

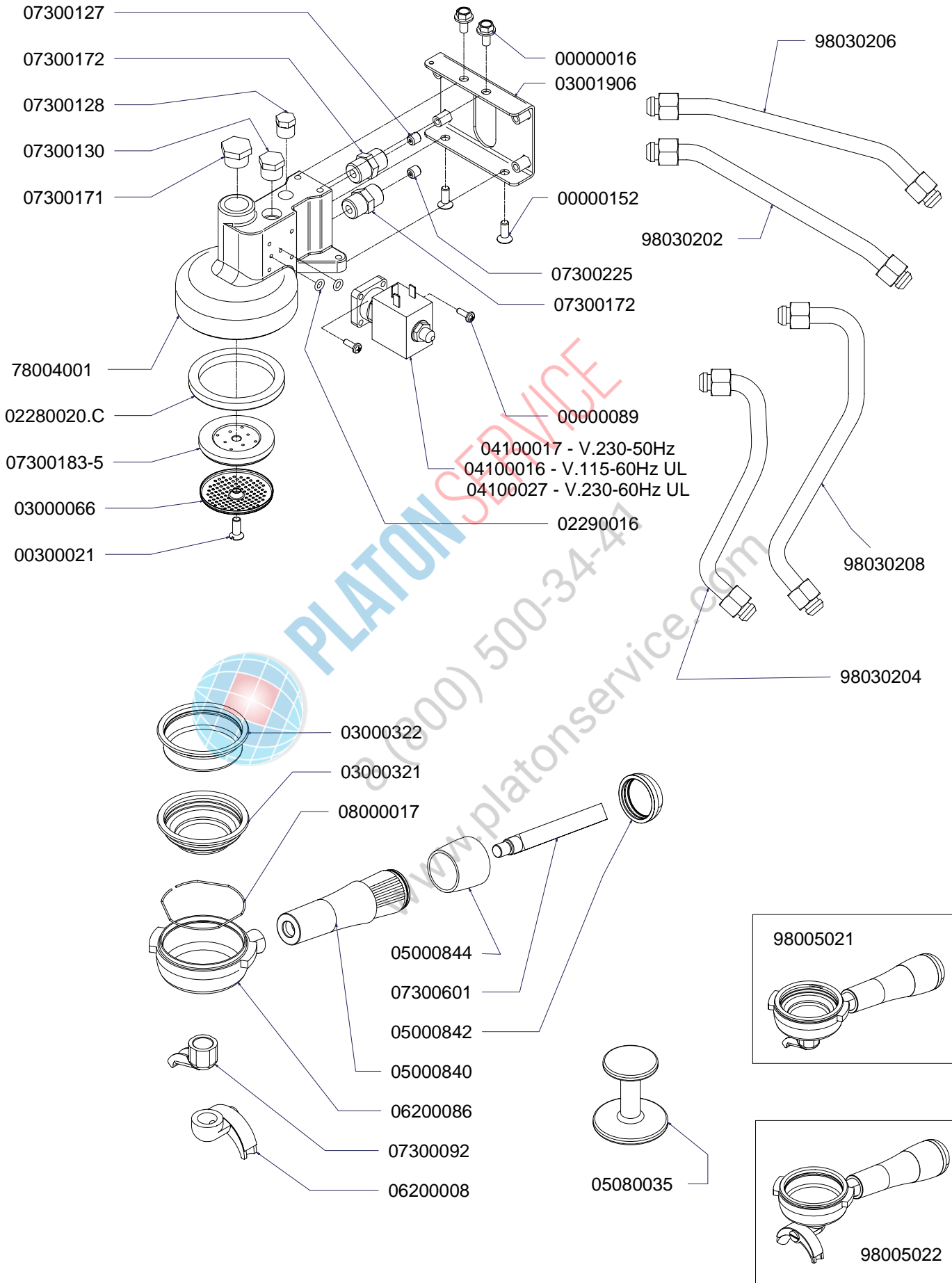

COMPONENTI IDRAULICI

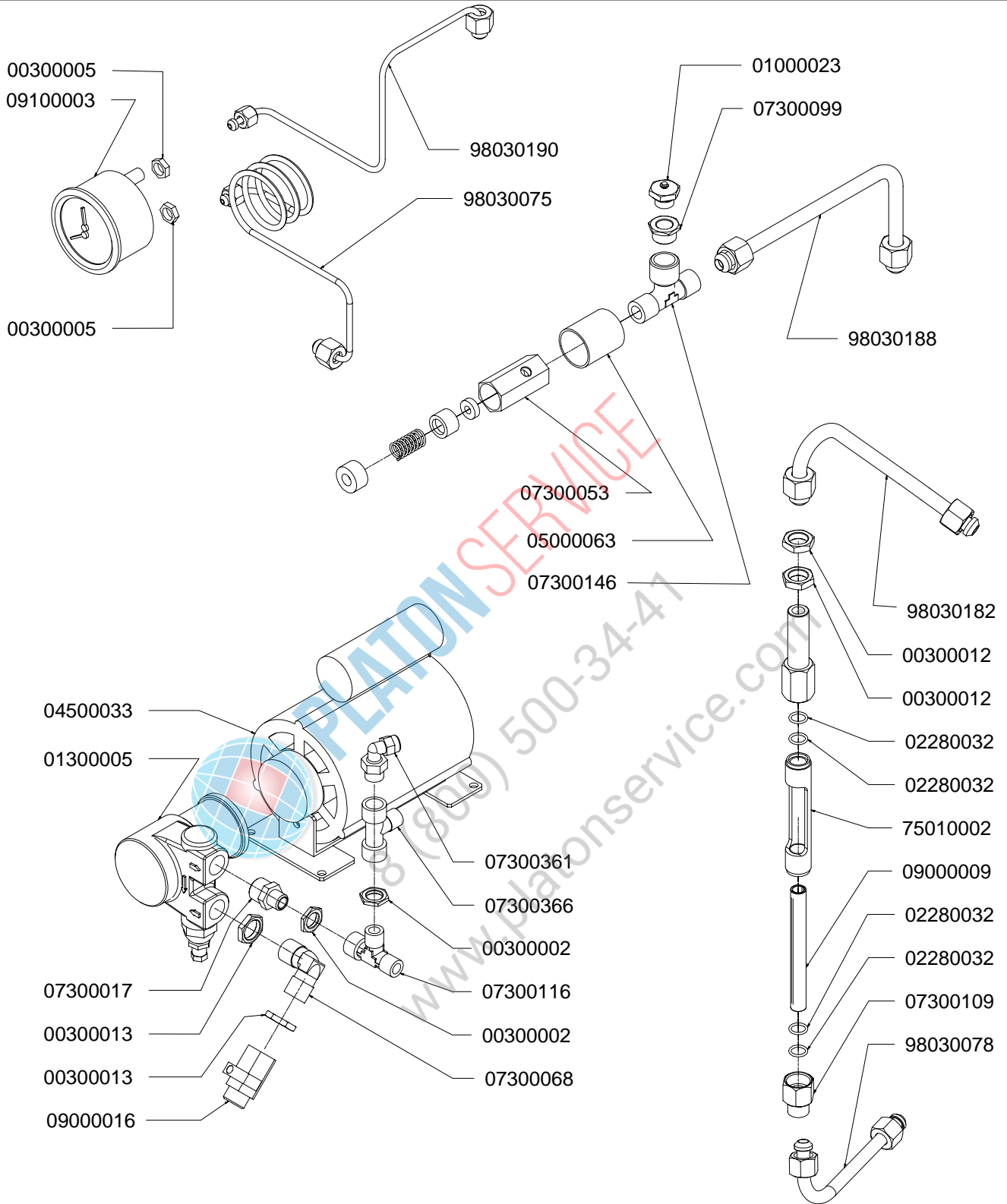

COMPONENTI IDRAULICI

CODICE	DESCRIZIONE	DES ING
01000113	TUBO INGRESSO	Valore
01000012	TUBO SCARICO	Valore
01000087	TUBO SCARICO	Valore
00000086	FASCETTA	Valore
00000133	FASCETTA	Valore

COMPONENTI IDRAULICI 3 GRUPPI

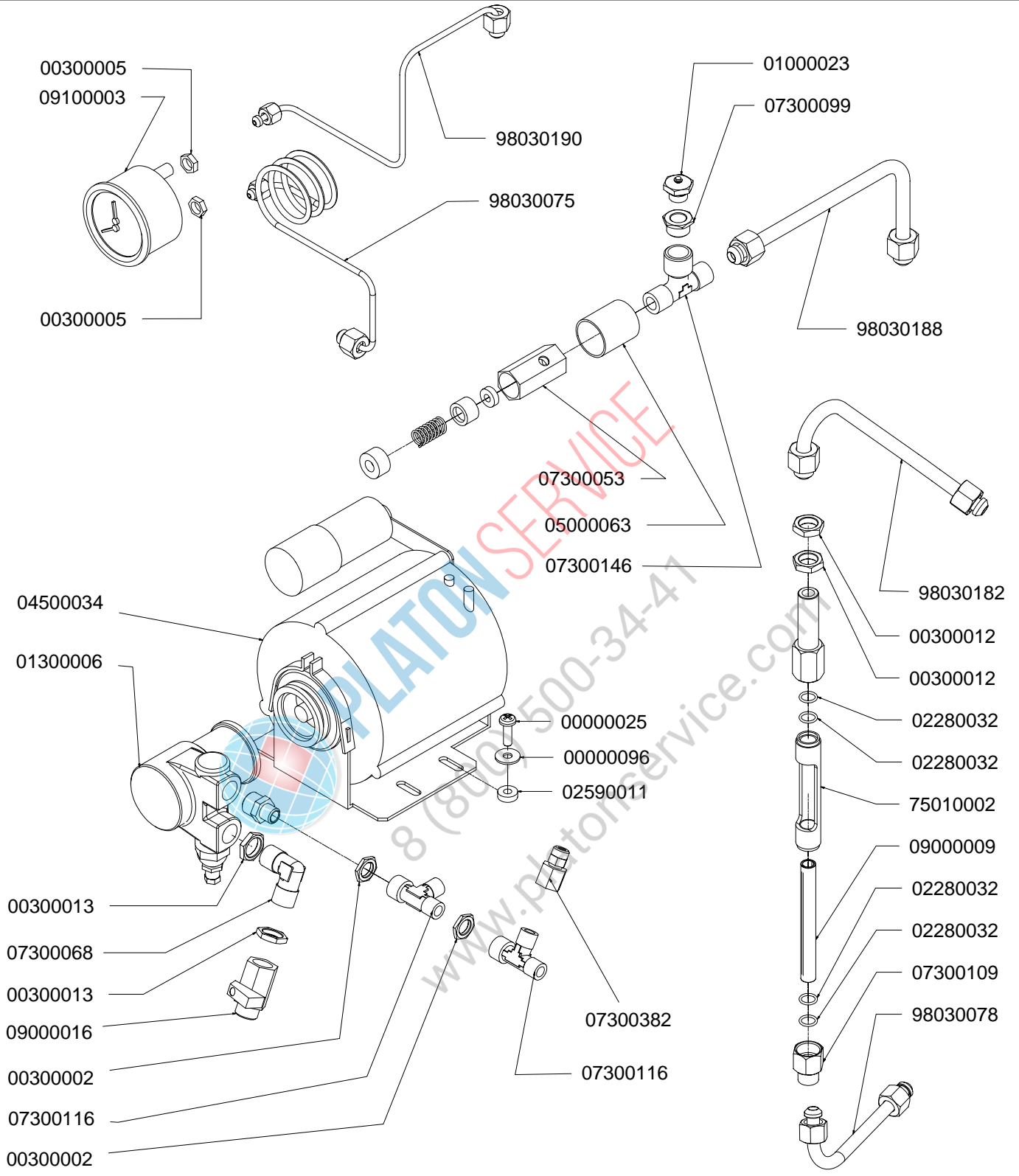

COMPONENTI IDRAULICI

CODICE	DESCRIZIONE	DES ING
01000113	TUBO INGRESSO	Valore
01000012	TUBO SCARICO	Valore
01000087	TUBO SCARICO	Valore
00000086	FASCETTA	Valore
00000133	FASCETTA	Valore

COMPONENTI RUBINETTI VAPORE ACQUA CALDA

APPIA 2-3GR SPAREPARTS

A
P
P
I
A

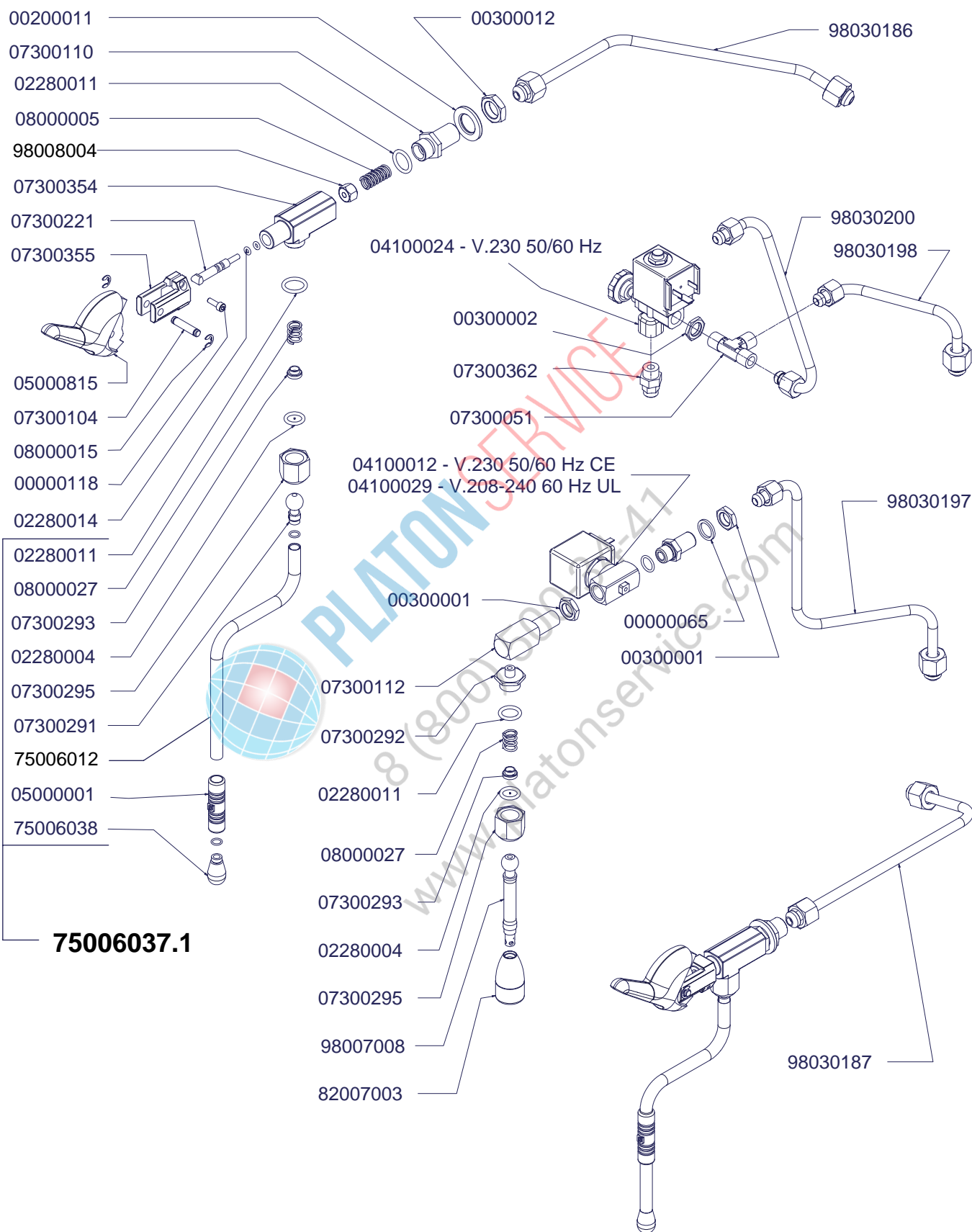

COMPONENTI GRUPPO IDRAULICO

A
P
P
I
A

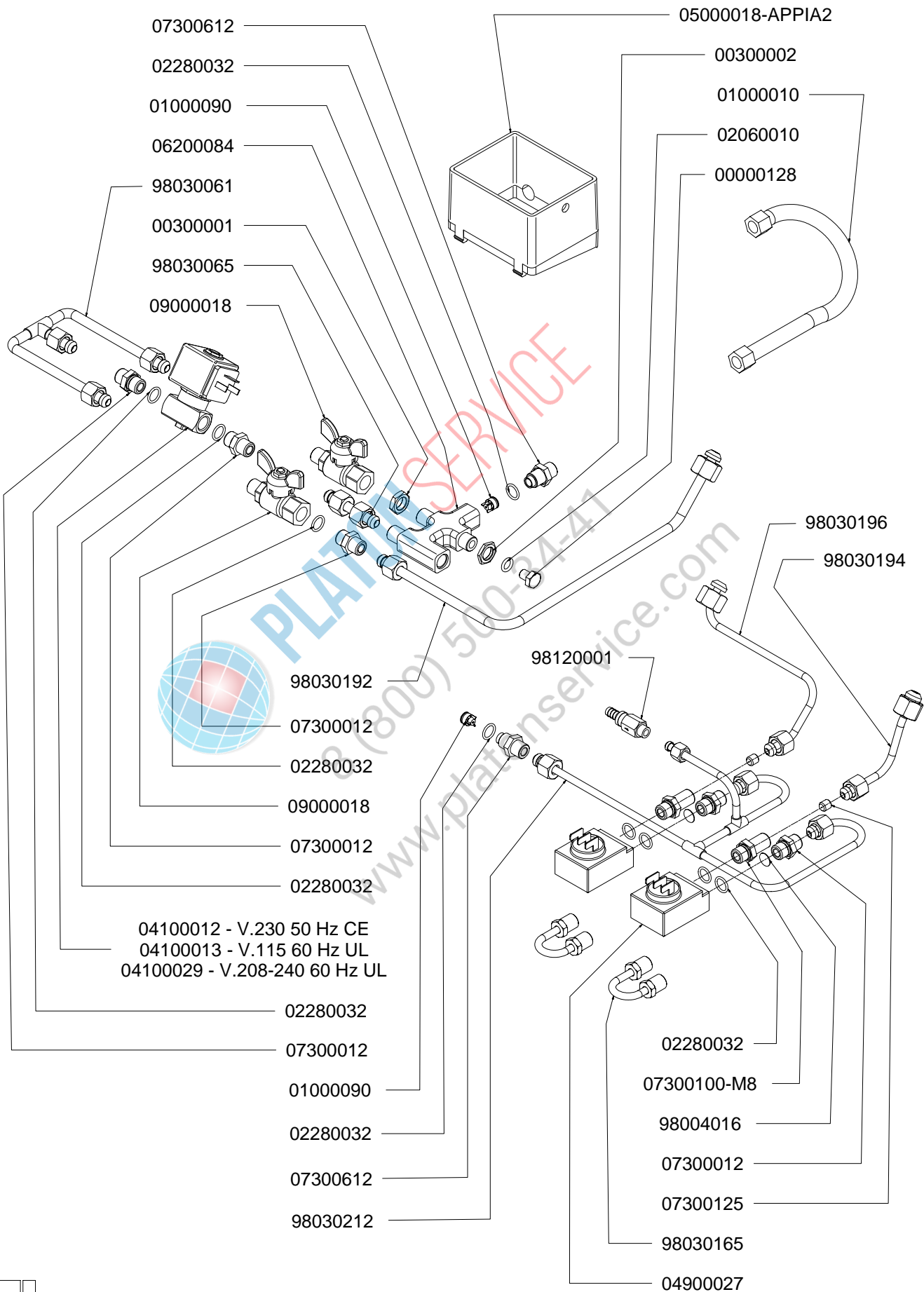

COMPONENTI GRUPPO CALDAIA

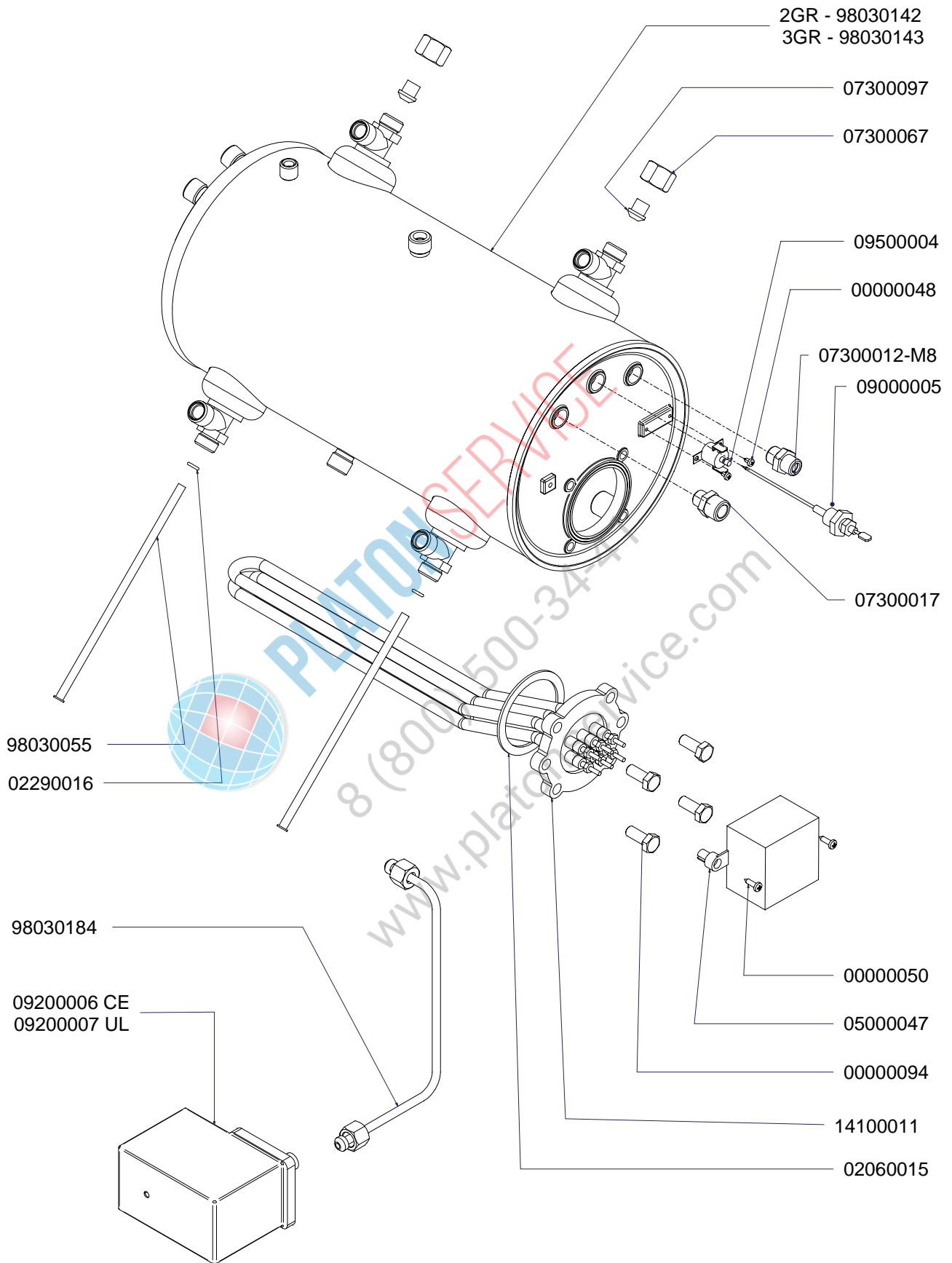

COMPONENTI TELAIO 2-3 GRUPPI

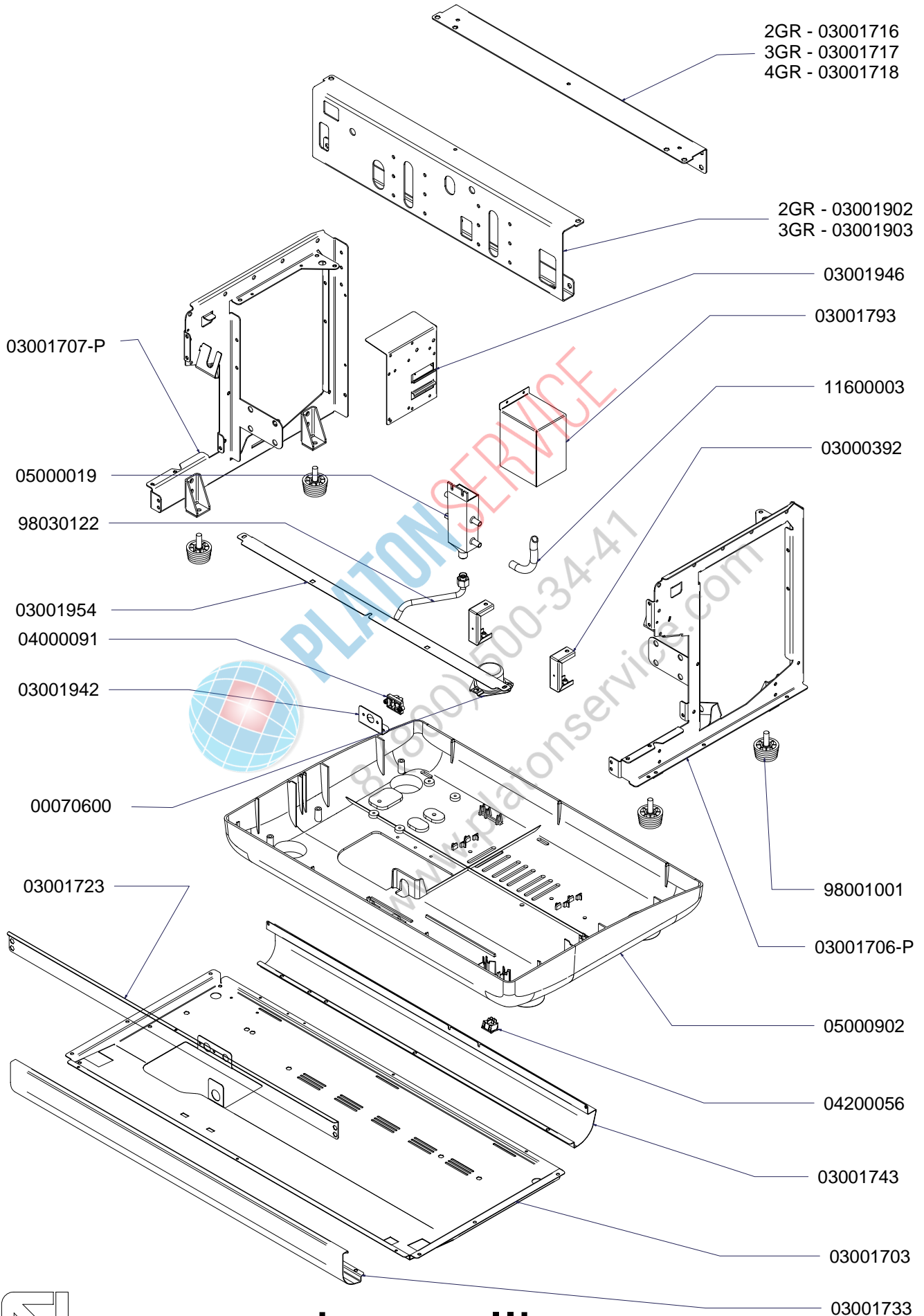

COMPONENTI ELETTRICI

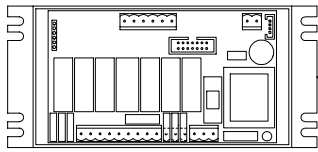

2GR - 04900732

3GR - 04900733

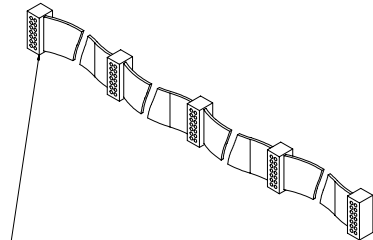
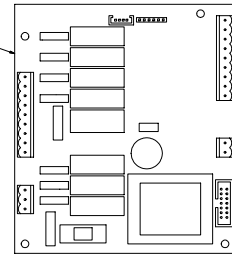

2 GR - 04000812
3 GR - 04000813

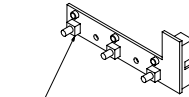

04900737

2GR - 05000919
3GR - 05000920

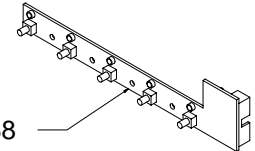

04900738

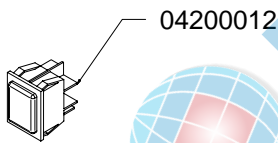
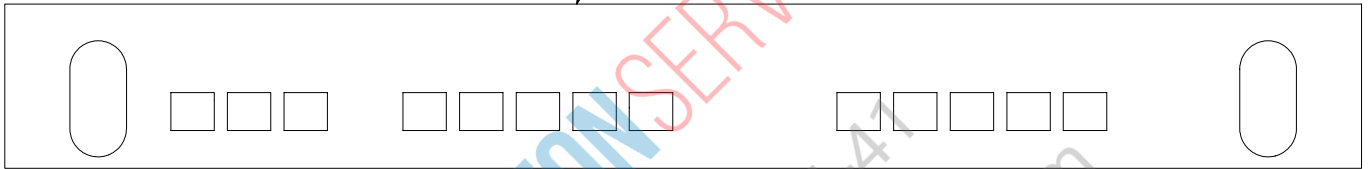

04200012



04200011

2GR - 05000921
3GR - 05000922

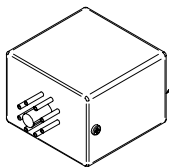

09000004



04200057

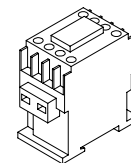

04200019

COMPONENTI ELETTRICI

COD.	DESCRIZIONE	DES. ING.
04000805	IMPIANTO ELETTRICO V.	Valore
04000807	IMPIANTO ELETTRICO S.	Valore
04000806	IMP.ELETTRICO SCALDATAZZE	Valore
04000807.P	IMP. ELET. PULSANTIERA S.	Valore
XXXXXX	XXXXXXXXXX	Valore
XXXXXX	XXXXXXXXXXXX	Valore